

# INSTALLATION INSTRUCTIONS

## Gridded Shower Panel

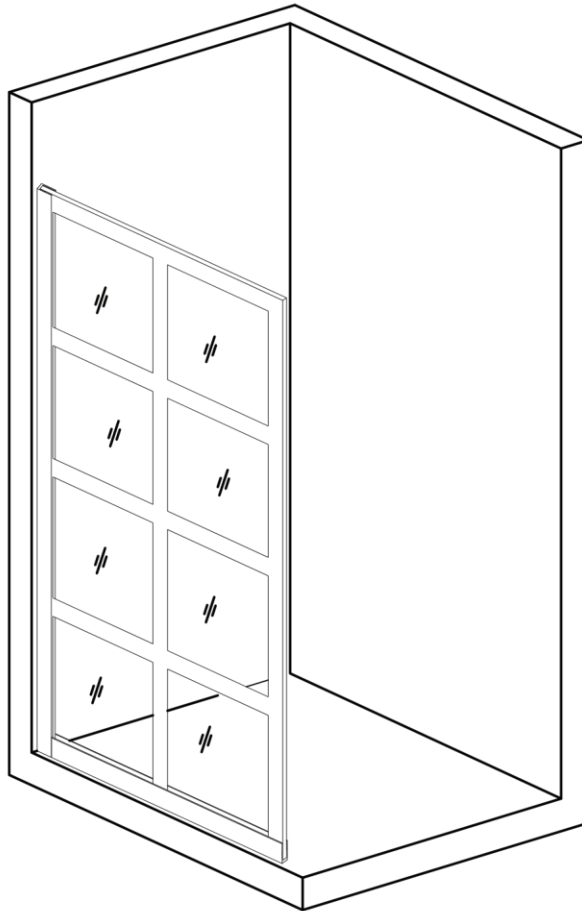

Please carefully read the installation instructions before installing. Check to make sure all of the accessories are in the package and you have the tools needed. It may be necessary to consult your tile supplier about the correct method for drilling tiles.



In the unlikely event that there are any missing or damaged parts, please contact Fab Glass and Mirror directly at [888-474-2221](tel:888-474-2221).

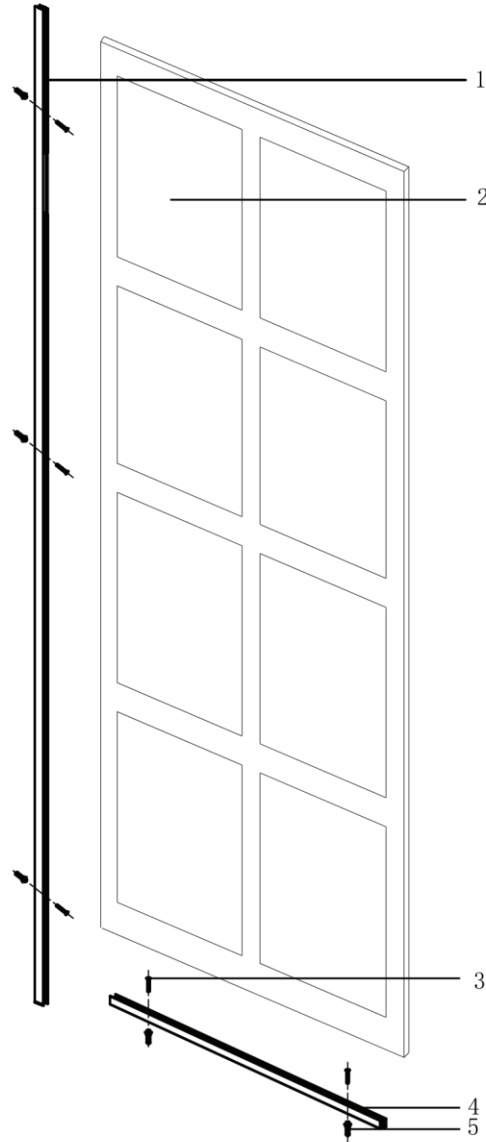

**CAUTION:** Risk of injury or product damage. During installation tempered glass should not come in direct contact with metal parts or it may shatter. Gaskets must always be used between glass and metal. Do not touch the edges of tempered glass with tools. Do not attempt to cut tempered glass as it will shatter.

**NOTE:** Tempered safety glass is stronger than normal glass but is not unbreakable. A scratch on the glass or contact with a hard surface (such as a screw head) can cause it to break. If it does break, it loudly explodes into thousands of small pieces.

# 1 Accessory list



NO	Description	Diagram	Unit	QTY
1	KW-A038 Profile		pc	1
2	Fixed glass panel		pc	1
3	Screw	 ST4*38	pc	5

NO	Description	Diagram	Unit	QTY
4	KW-A038 Profile		pc	1
5	Wall Plug		pc	5
6				

2

## Tools for installation

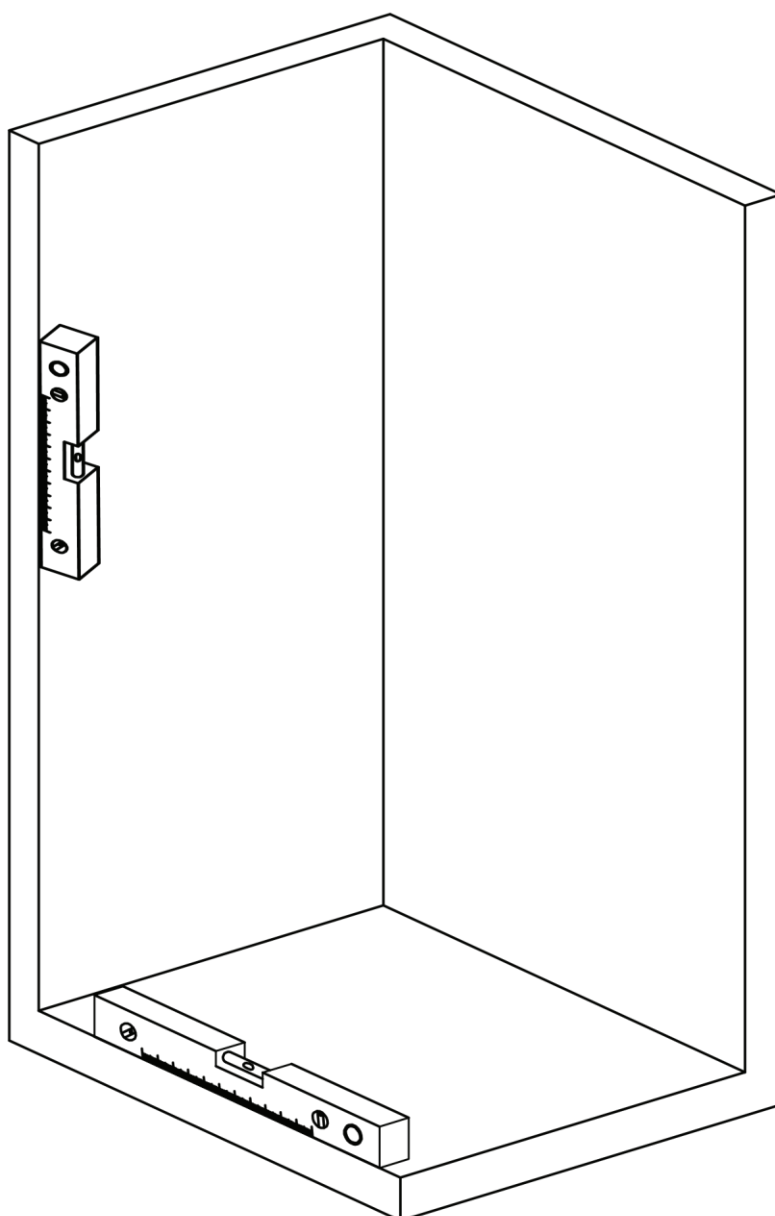
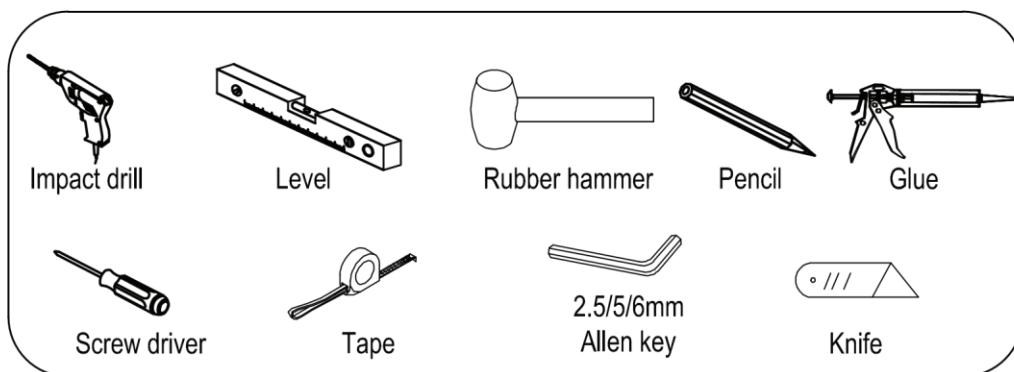

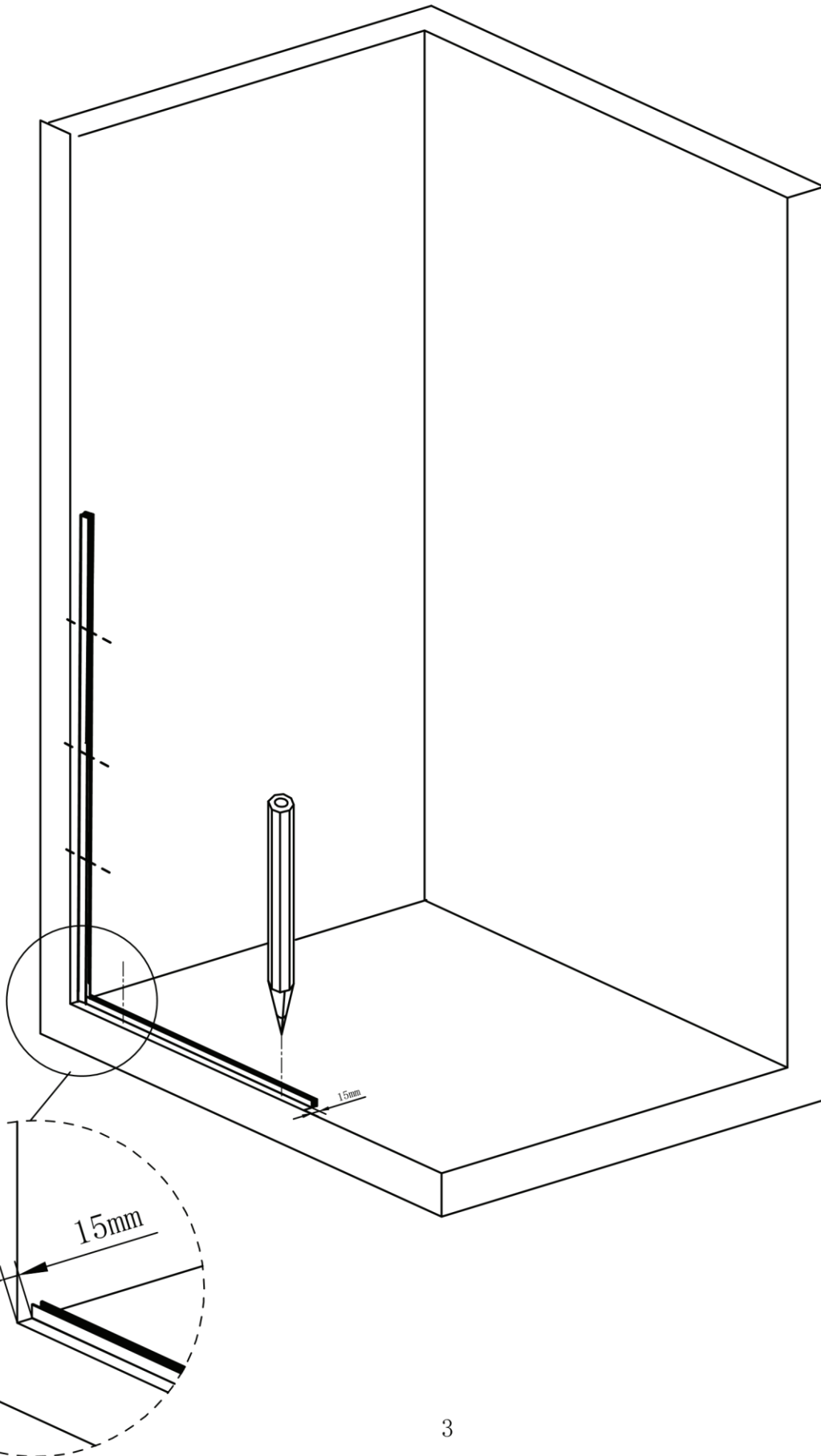

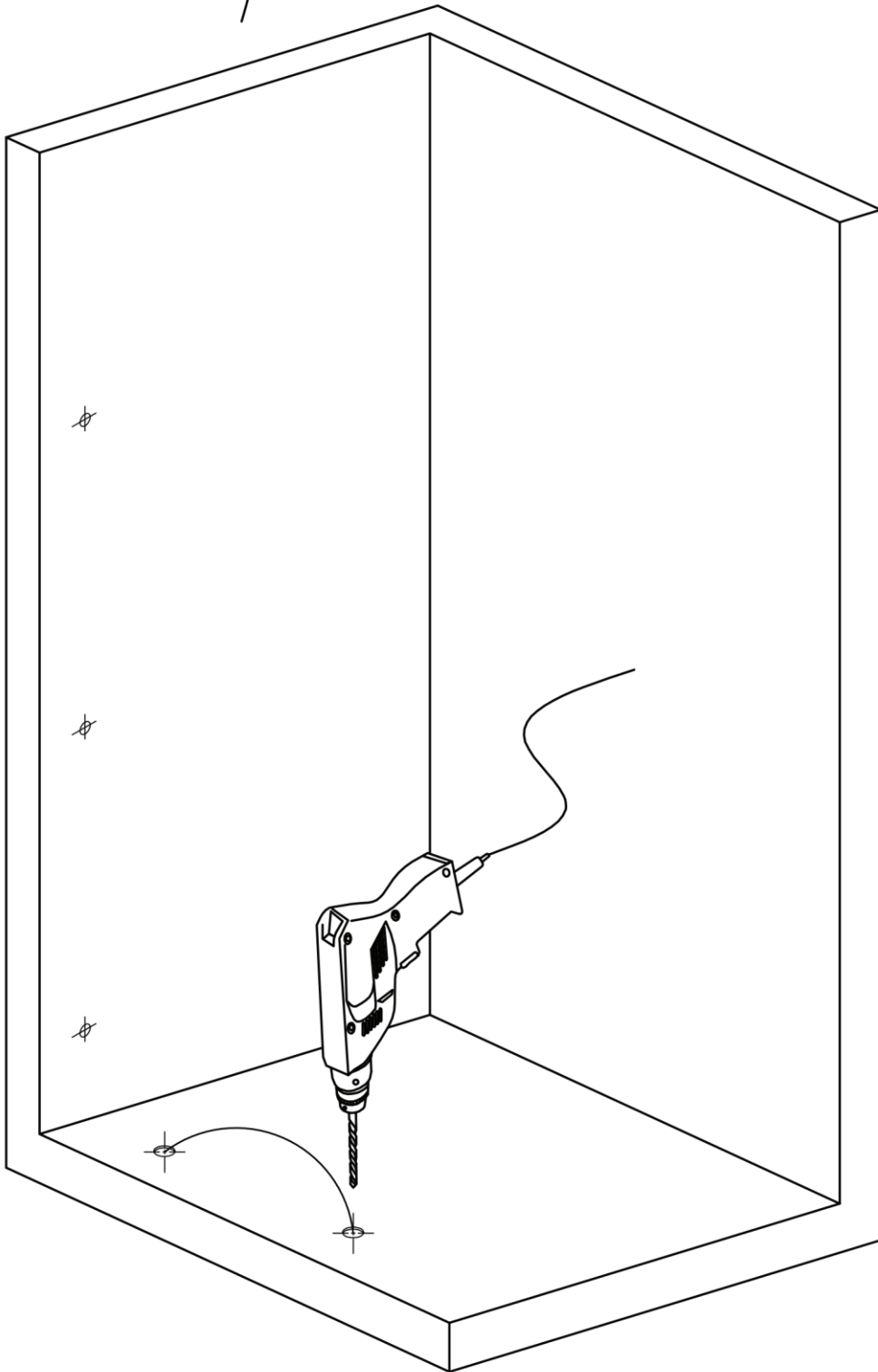
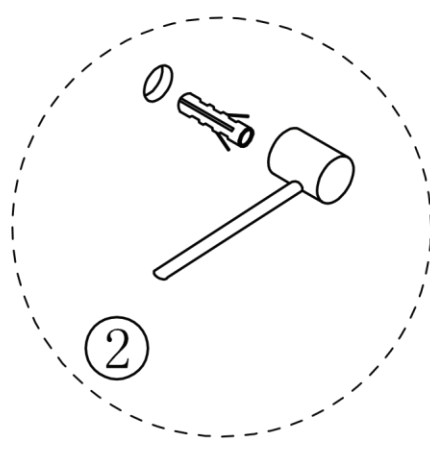
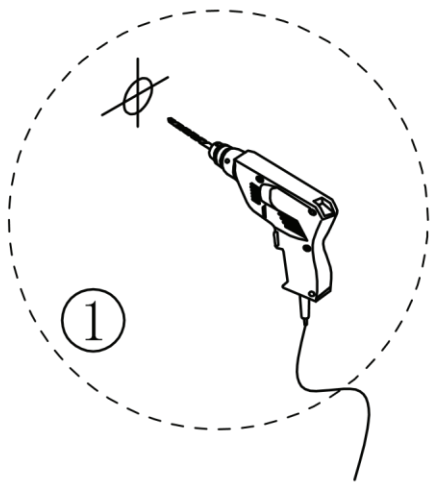

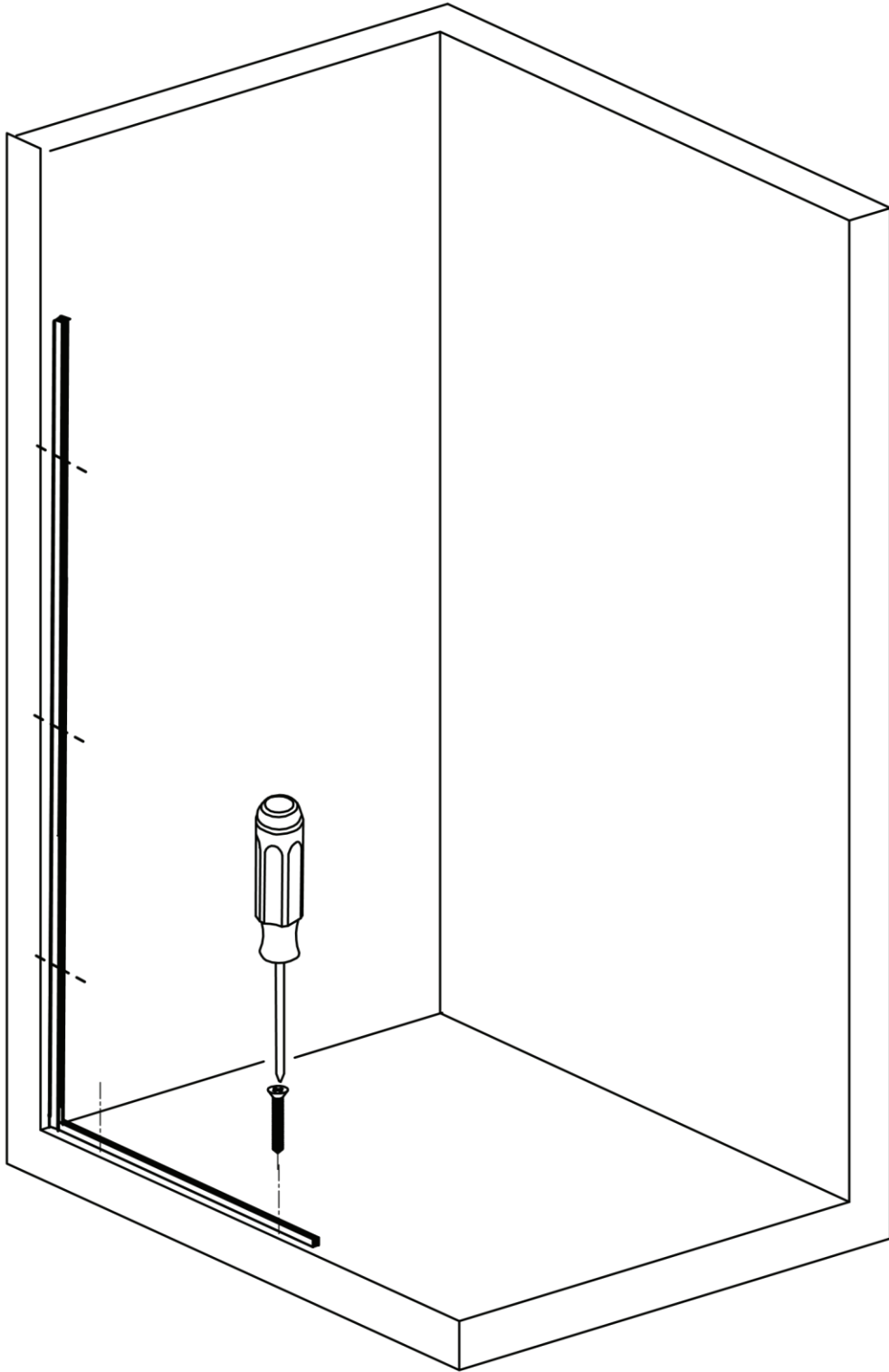

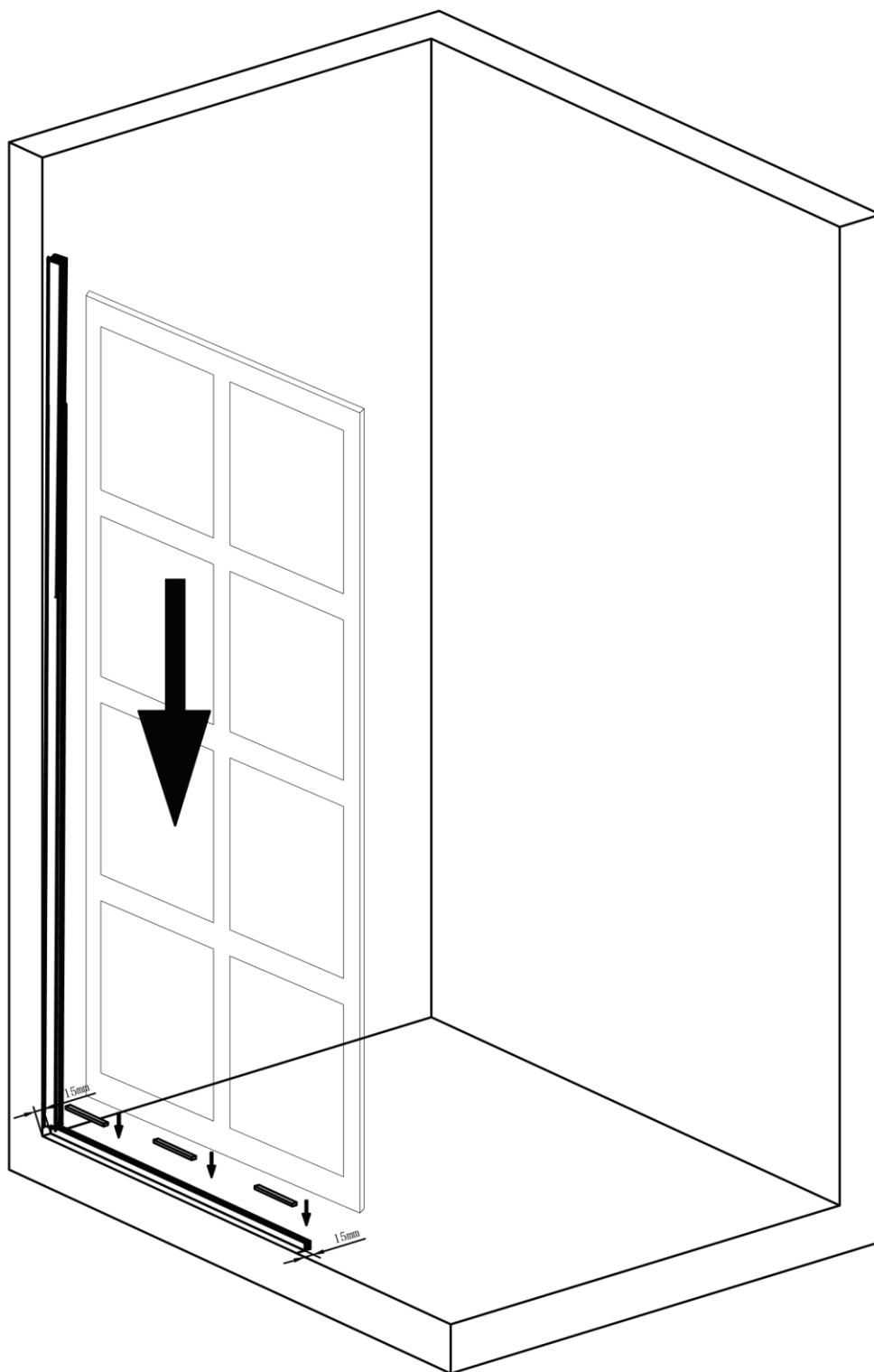

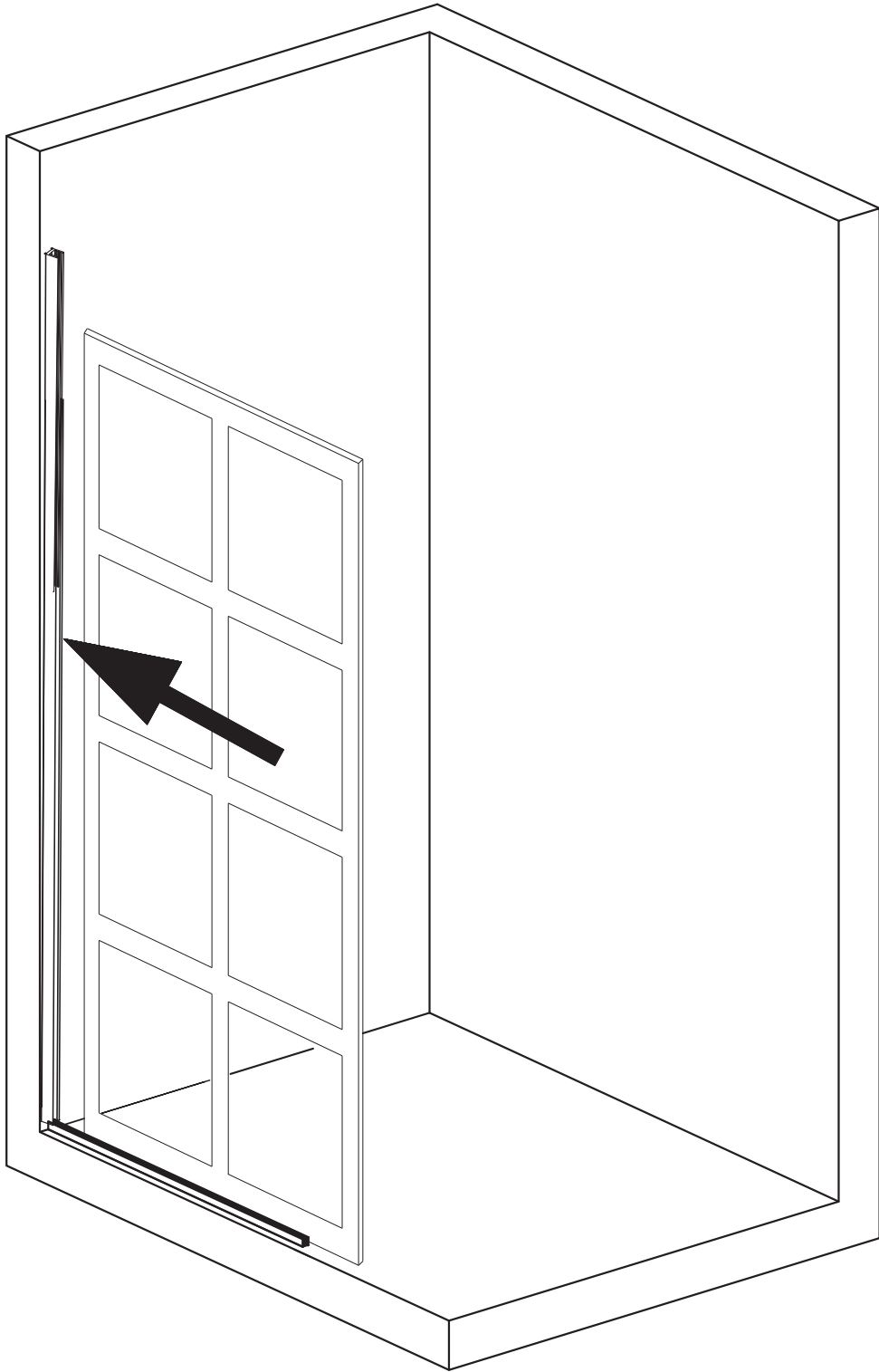

To avoid water leaks, use silicone to seal the slit between the wall & profile, the fixed glass panel, and the tray.

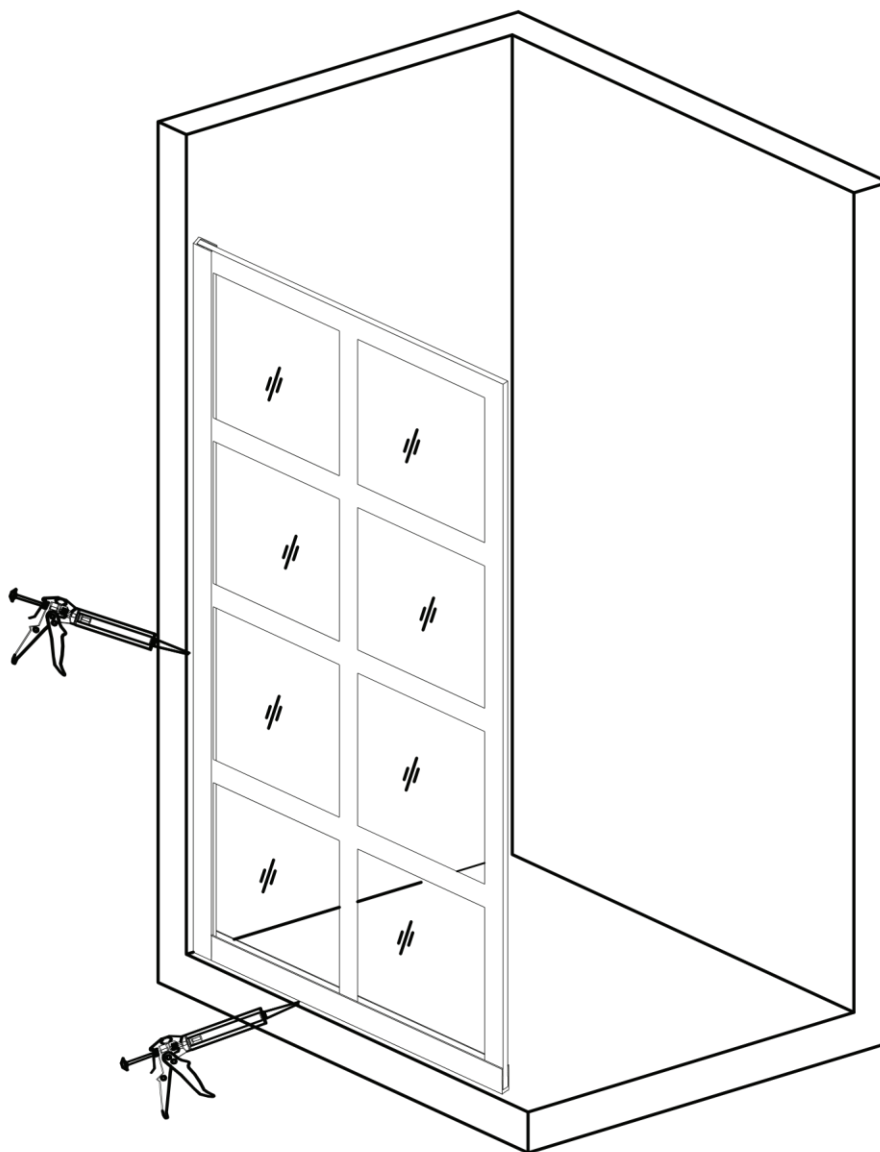
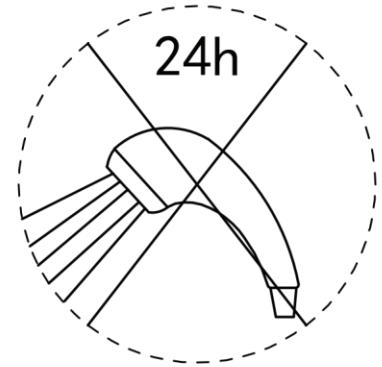

## **Maintenance of Shower Enclosure**

**1. Cleaning** Use a soft, dry cloth to clean the shower enclosure and shower tray. If there is minor dirt, use a soft cloth or sponge dampened with a mild detergent to clean. To remove stubborn dirt, use alcohol. When cleaning with a bathroom cleanser, follow the label instructions and use correctly.

hydrochloric acid, acetone thinners or scouring powder.

## **2. Usage and maintenance of shower door rollers**

- 1) Avoid striking the movable door, which may cause it to come loose.
- 2) Clean rails, wheels, sliders regularly; add lubricant (oil or lubricating wax).
- 3) Adjust the screws of sliders on a regular basis to ensure the sliders operate smoothly.

## **3. Maintenance of Tempered Glass**

- 1) Do not use sharp objects against the surface to avoid damage.
- 2) Do not wipe the glass surface with corrosive liquids to avoid damaging the glossy surface.
- 3) Do not wipe the surface with an abrasive material to avoid scratches.

## **4. Maintenance of Aluminum Frame**

- 1) Do not wipe with corrosive liquids or materials.
- 2) Do not use abrasive material (including toothpaste) for surface cleaning.
- 3) Do not scratch the surface with sharp objects.